

 PIONEER®

## LD-V1000 INTERFACE GUIDE

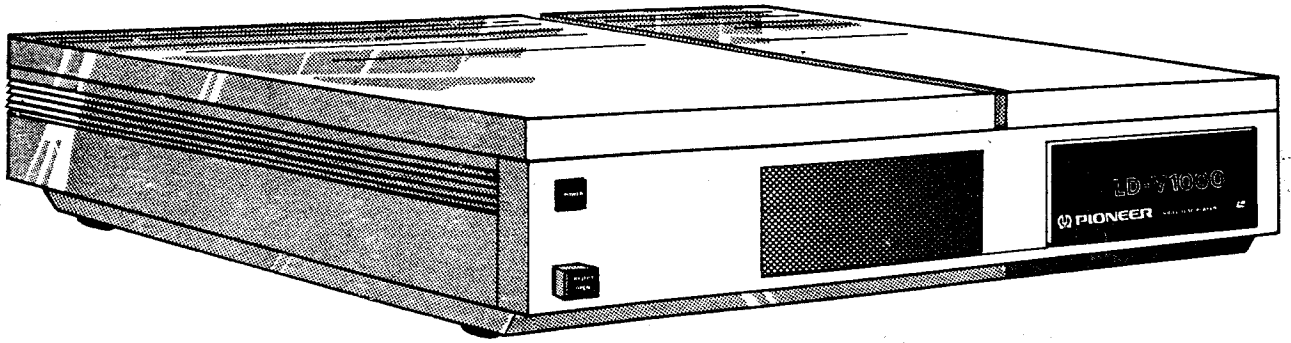

TABLE OF CONTENTS

<u>Section</u>	<u>Page</u>
I. <b>General Information</b> . . . . .	1
II. <b>Mechanical and Electrical       Interface Connections</b>	
Connectors, Cables, Voltages, and Player Interface Circuitry . . . . .	1
Player Interface Circuits . . . . .	3
Typical Hardware Interface . . . . .	4
III. <b>LD-V1000 Command Summary</b>	
General Control Commands . . . . .	5
Player Status and Memory Transfer Commands . . . . .	9
IV. <b>Software Interface Considerations</b>	
General Comments . . . . .	13
Program Interface Sequence of Events . . . . .	13
Player-to-host Data Transmission Protocol . . . . .	17
V. <b>Appendix</b>	
Status Code Summary . . . . .	19
LD-V1000 Command Byte Chart . . . . .	20
LD-V1000 Player Specifications . . . . .	21
<b>User's Record</b> . . . . .	24
<b>Comment Form</b> . . . . .	25

LIST OF FIGURES

<u>Figure Number</u>		<u>Page</u>
1:	Interface Port and Connections . . . . .	2
2:	Interface Voltage Levels . . . . .	3
3:	LD-V1000 Interface Circuits . . . . .	3
4:	Typical Hardware and Interface Connections . . . . .	4
5:	LD-V1000 Computer Interface Commands . .	10/11
6:	Approximate Time Values . . . . .	15
7:	Linear Sequence of Events . . . . .	15
8:	Command Timing Example . . . . .	16
9:	Player-to-host Data Protocol . . . . .	17
10:	Status Code Summary . . . . .	19
11:	LD-V1000 Command Byte Chart . . . . .	20

## LD-V1000 INTERFACE GUIDE - TP107

### I. GENERAL INFORMATION

This guide provides the information needed to interface the Pioneer LD-V1000 LaserDisc™ Player to an external controller or host processor. Interfacing to the LD-V1000 can be accomplished either through a custom hardware connection, or through appropriate software, using an eight bit, bi-directional port and two "handshake" lines (as a minimum).

Using a custom hardware interface can reduce some of the time critical requirements of the host system software by latching the data between the player and the host, thus making possible somewhat more asynchronous communication between them.

**WARNING:** Although the Pioneer LD-V1000 and Pioneer PR7820 series players use Amphenol type, 24-pin connectors, interfaces designed for the PR7820 are not likely to be compatible with the LD-V1000 unless they have been suitably modified. Interfaces not specifically designed for the LD-V1000 Player may damage its output drivers.

### II. MECHANICAL AND ELECTRICAL INTERFACE CONNECTIONS

#### 1. Connectors, Cables, Voltages, and Player Interfaces Circuitry

The LD-V1000 control port is a 24-pin Amphenol Type 57-40240 jack located on the connector panel at the rear of the player. Figure 1 shows the connector pin layout and lists signal lines by contact number. Standard ribbon cable can be used for the host computer to LD-V1000 cabling. Figure 2 provides required input and output voltage levels. Figure 3 shows the internal player circuits attached to the LD-V1000 control port.

\* LaserDisc is a trademark of Pioneer Electronic Corporation.

# Interface Connector

Type: Amphenol DDK 57-40240

Contact Layout:

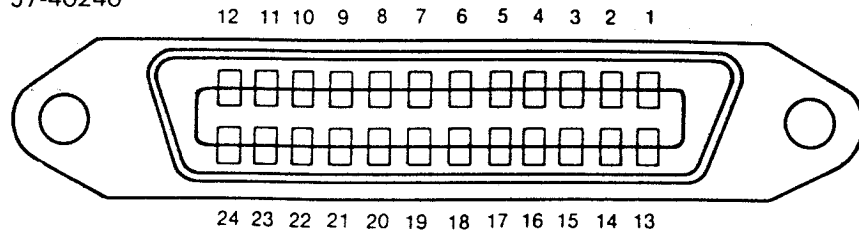

CONTACT #	SIGNAL LINE	DIRECTION	
1	DIO1		
2	DIO2		
3	DIO3		
4	DIO4		
5			
6			
7	COMMAND STROBE*	Out of player	
8			
9			
10			
11	STATUS STROBE*		Out of player**
12	GND		
13	DIO5		
14	DIO6		
15	DIO7		
16	DIO8		
17	ENTER SIGNAL		Into player***
18	GND		
19	GND		
20	GND		
21	GND		
22	GND		
23	GND		
24	GND		

\* **Warning:** Do not short to ground.

\*\* **Note:** Directional change from PR7820.

\*\*\* **Note:** Functional change from PR7820. ENTER should be connected to COMMAND STROBE or GND.

**FIGURE 1: INTERFACE PORT AND CONNECTIONS**

## 2. Player Interface Circuits

### Output Voltage

SIGNAL LINE	HIGH LEVEL	LOW LEVEL
DATA BUS	2.7V min.	0.4V max. (IOL = 8mA)
STATUS STROBE	2.7V min.	0.4V max. (IOL = 4mA)
COMMAND REQUEST	2.7V min.	0.4V max. (IOL = 4mA)

### Input Voltage

SIGNAL LINE	HIGH LEVEL	LOW LEVEL
DATA BUS	2.0V min.	0.8V max.
ENTER SIGNAL	3.5V min.	1.5V max.

FIGURE 2: INTERFACE VOLTAGE LEVELS

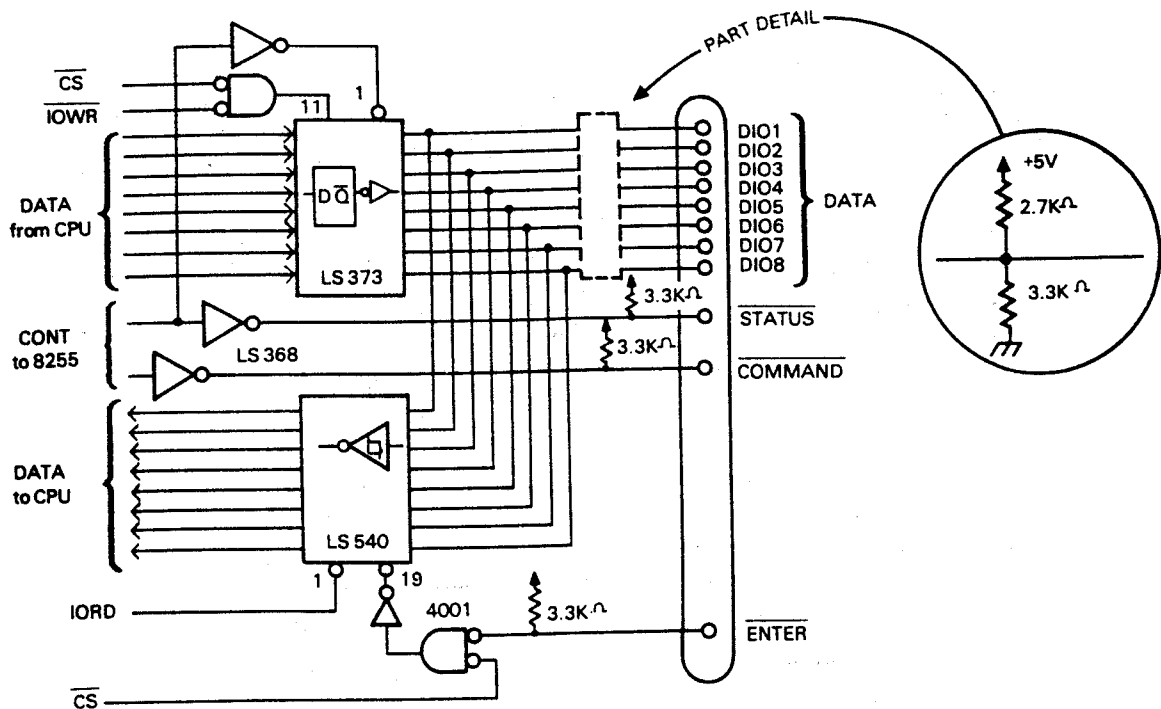

FIGURE 3: LD-V1000 INTERFACE CIRCUITS

## 2. Typical Hardware Interface

Figure 4 shows a possible interface for connecting the LD-V1000 Player to a host computer.

Among the ICs that might be used are:

- Z1 - 74LS123
- Z2 - 74LS273
- Z3 - 74LS244

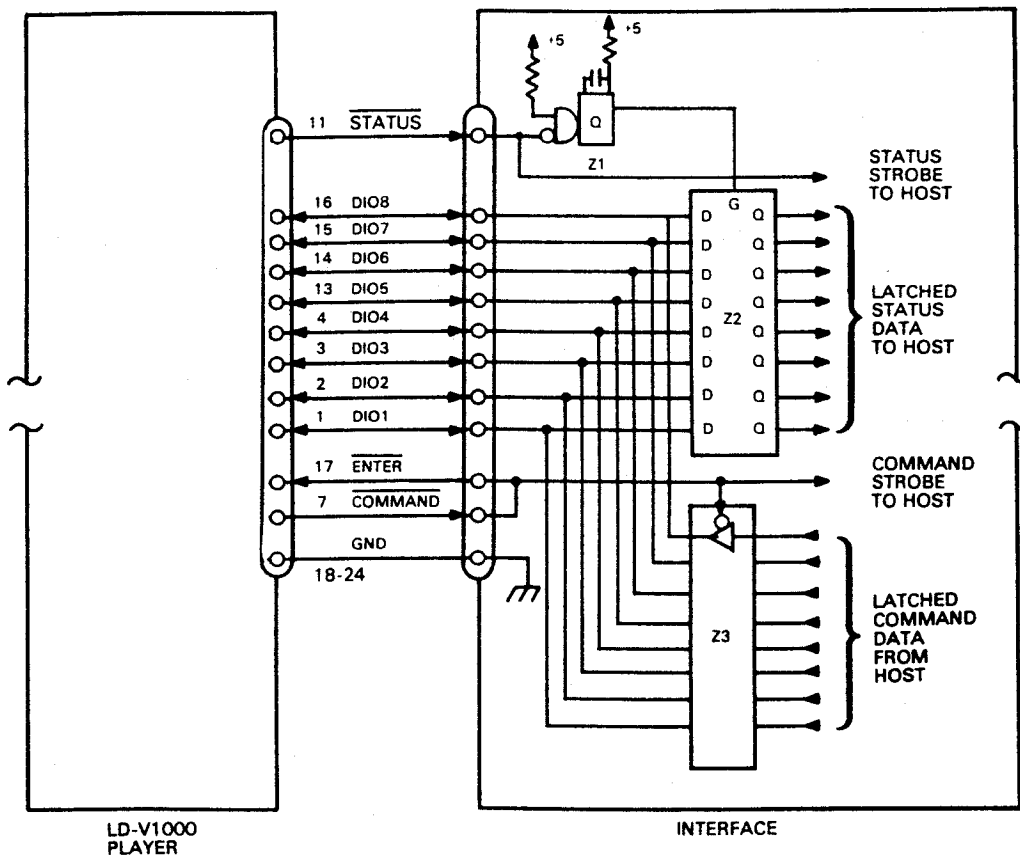

**FIGURE 4: TYPICAL HARDWARE AND INTERFACE CONNECTIONS**

### III. LD-V1000 COMMAND SUMMARY

#### 1. General Control Commands

The LD-V1000 LaserDisc Player will execute all of the following control commands. Figure 5 shows the binary code and hex equivalents for each command.

#### Arguments

#### Command Description

0 ... 9

Digits 0 through 9 are used to express the argument portion of various commands. For example, 03459 followed by the command for SEARCH will cause the player to search to frame 3459.

#### Motion Control Commands

#### Command Description

PLAY

If the disc on a player is in the PARK position (just loaded, but not turning), the PLAY command starts the "spin-up" cycle, which finishes when focus is achieved. The player then begins playing the disc at Frame 1, assuming the disc is an NTSC CAV type. If a non-NTSC or CLV disc is loaded, "spin-up" will abort (reject).

Following "spin-up," PLAY causes the player to begin playing a videodisc at 30 frames per second in the forward (increasing frame number) direction. The PLAY command remains active until one of the following motion control commands is given: STOP, SEARCH, AUTOSTOP, STEP FORWARD, STEP REVERSE, X0 ... X5 FORWARD.

(arg) STOP

STOP aborts the current motion state and causes the player to freeze frame (play the same video track repeatedly). If an argument value precedes the STOP command, the player will freeze frame and return a "busy" status for (0.1 x argument) seconds. While in STOP mode, audio is squelched.

SCAN FORWARD,  
SCAN REVERSE

The two SCAN commands move the player's optical head at the rate of approximately 2000 frames per second in the direction specified. These two commands are used primarily in manual operation for visually locating a general area on the videodisc. The SCAN commands cannot be used to scan to a specific frame number.



Motion  
Control  
Commands (cont'd)

STEP FORWARD  
STEP REVERSE

The STEP commands abort the current motion state, increment (or decrement) the current frame number by one, and freeze frame there. During freeze frame, the audio is squelched.

(arg) SEARCH

SEARCH causes the player to locate and freeze frame on the frame specified by the active argument. If no argument is given, the SEARCH frame number is taken from the active register, and the active register pointer is incremented.

(arg) AUTOSTOP

AUTOSTOP begins or continues normal speed (30FPS) play of a videodisc, starting at the current frame number and ending in freeze frame mode at the frame specified by the active argument. If no argument is specified, the ending frame number is taken from the active register and the active register pointer is incremented. An ending frame number that is of lower value than the current frame number will cause a search to that frame, but will not cause reverse play.

X0 ... X5 FORWARD

These eight commands cause the player to play forward at one of eight different speeds: 0, 1/4, 1/2, 1, 2, 3, 4, and 5 times the normal (30 frames per second) rate. The audio channels can be activated during FORWARD play by executing a PLAY command before sending one of the FORWARD commands. Then, by using the AUDIO commands, the audio can be turned on or off.

10 ... 100 SKIP

These ten commands instruct the player to skip forward 10, 20, 30, 40, 50, 60, 70, 80, 90, or 100 tracks respectively, from the current position. One of the FORWARD player commands must be executed prior to sending one of these commands; otherwise, the SKIP commands will be ignored. Following execution of a SKIP, the previously selected FORWARD function resumes. The SKIP commands do not affect existing audio instructions.

Motion  
Control  
Commands (cont'd)

The SKIP commands cause the player to skip tracks, not frames. The number of tracks and number of frames may or may not correspond, depending on the video format of the source materials used. Tracks and frame numbers will not correspond, for instance, if three/two pulldown was used to transfer 24fps film source material to the master tape.

Although the skip values are typically accurate within + one track (+ five tracks max.), SKIP should not be relied upon for absolute frame-accurate positioning of the laser read head. After a SKIP, there must typically be a head-settle time of 10 fields (170 ms).

Display  
Commands

Command Description

(arg)FRAME  
DISPLAY

FRAME DISPLAY with no argument toggles the frame display on and off. If "1" or another odd number argument precedes the DISPLAY command, the frame display will be turned on; if the argument is "0" or another even number, the display will be turned off.

DISPLAY ENABLE,  
DISPLAY DISABLE

These two commands enable (or disable) the player's character generator output to the video monitor. When the character generator display is disabled, the functions which would normally be displayed function as normal, but are not shown on the video screen.

Audio Commands

Command Description

(arg)AUDIO1,  
(arg)AUDIO2

The AUDIO commands toggle their respective audio channels. A "1" or other odd number argument preceding an AUDIO command will turn that audio channel on; a "0" or other even number will turn that audio channel off.

Memory Commands      Command Description

(arg) STORE              STORE causes the present argument to be stored in the active register, and increments the active register pointer. Registers can contain values from 0 through 65535. Values greater than 65535 are interpreted as modulo 65536. When STORE is not preceded by an argument, the current frame number is stored in the active register.

(arg) RECALL             RECALL activates the register specified by the argument and displays the contents of that register. If no argument precedes the RECALL command, the register display is activated. Subsequent RECALL commands advance the active register pointer. (SEARCH and AUTOSTOP, described previously, also increment the active register under certain conditions.)

CLEAR                    This command clears the register display and removes any pending argument from the active argument buffer.

LOAD                     LOAD causes the player to search to the frame specified in register zero and load the dump (1022 bytes) located there into the player's RAM memory. The RAM memory can be used to store any information the user specifies, including such data as disc identification, disc side identification, or frame numbers for use with the SEARCH and AUTOSTOP commands.

Operating  
Commands

Command Description

REJECT                  The REJECT command causes the videodisc to stop playing and disc rotation to stop. At the same time the player's optical head returns to the PARK position.

NO ENTRY                NO ENTRY is a "null" COMMAND. It is used as a prefix before each command that is sent to the player, and is available as a programming convenience where needed. Whenever another specific command is not being applied, the NO ENTRY command should be applied to the player.

## 2. Player Status and Memory Transfer Commands

The following four commands transmit various items of player status and stored memory information during subsequent status intervals. (See Section IV.3.) The first sends five ASCII characters, the second two send eight ASCII characters each, and the fourth sends 1024 bytes of eight bit data. If the display is not active, non-ASCII data is sent. "Blanked" characters are "1C" hex.

<u>Status Command</u>	<u>Command Description</u>
GET FRAME NO. (5 characters)	This command transmits the current frame number to the host computer.
GET FIRST DISPLAY LINE (8 characters)	This command transmits the current contents of Display Line One (which may be the active register number or the current frame number) to the host.  <u>Caution:</u> If FRAME DISPLAY is disabled and neither (arg)RECALL nor an argument has been issued, the "data" obtained by GET FIRST DISPLAY LINE will have no meaning.
GET SECOND DISPLAY LINE (8 characters)	This command transmits the current contents of Display Line Two (which may be the argument just entered, or the contents of the present active register) to the host.  <u>Caution:</u> If neither (arg)RECALL nor an argument has been issued, the "data" obtained by GET SECOND DISPLAY LINE will have no meaning.
TRANSFER MEMORY (1024 bytes)	This command causes the entire contents of the player's RAM to be transmitted to the host.

Timing for these commands is discussed in Section IV of this Interface Guide, and is illustrated in Figure 7.

COMMAND	DIO								HEX DATA
	8	7	6	5	4	3	2	1	
CLEAR	1	0	1	1	1	1	1	1	BF
0	0	0	1	1	1	1	1	1	3F
1	0	0	0	0	1	1	1	1	0F
2	1	0	0	0	1	1	1	1	8F
3	0	1	0	0	1	1	1	1	4F
4	0	0	1	0	1	1	1	1	2F
5	1	0	1	0	1	1	1	1	AF
6	0	1	1	0	1	1	1	1	6F
7	0	0	0	1	1	1	1	1	1F
8	1	0	0	1	1	1	1	1	9F
9	0	1	0	1	1	1	1	1	5F
STORE	1	1	1	1	0	1	0	1	F5
RECALL	0	1	1	1	1	1	1	1	7F
DISPLAY	1	1	1	1	0	0	0	1	F1
AUDIO 1	1	1	1	1	0	1	0	0	F4
AUDIO 2	1	1	1	1	1	1	0	0	FC
PLAY	1	1	1	1	1	1	0	1	FD
STOP	1	1	1	1	1	0	1	1	FB
AUTOSTOP	1	1	1	1	0	0	1	1	F3
SEARCH	1	1	1	1	0	1	1	1	F7
SCAN FWD*	1	1	1	1	0	0	0	0	F0
SCAN REV*	1	1	1	1	1	0	0	0	F8
STEP FWD	1	1	1	1	0	1	1	0	F6
STEP REV	1	1	1	1	1	1	1	0	FE
REJECT	1	1	1	1	1	0	0	1	F9
NO ENTRY	1	1	1	1	1	1	1	1	FF

\*Must be applied continuously for duration of SCAN.

**FIGURE 5a: LD-V1000 COMPUTER INTERFACE  
COMMANDS - PART 1**

COMMAND	DIO								HEX DATA
	8	7	6	5	4	3	2	1	
LOAD	1	1	0	0	1	1	0	0	CC
DISPLAY DISABLE	1	1	0	0	1	1	0	1	CD
DISPLAY ENABLE	1	1	0	0	1	1	1	0	CE
GET FRAME NO.	1	1	0	0	0	0	1	0	C2
GET 2ND DISPLAY	1	1	0	0	0	0	1	1	C3
GET 1ST DISPLAY	1	1	0	0	0	1	0	0	C4
TRANSFER MEMORY	1	1	0	0	1	0	0	0	C8
X 0 FORWARD (STOP)	1	0	1	0	0	0	0	0	A0
X ¼ FORWARD	1	0	1	0	0	0	0	1	A1
X ½ FORWARD	1	0	1	0	0	0	1	0	A2
X 1 FORWARD	1	0	1	0	0	0	1	1	A3
X 2 FORWARD	1	0	1	0	0	1	0	0	A4
X 3 FORWARD	1	0	1	0	0	1	0	1	A5
X 4 FORWARD	1	0	1	0	0	1	1	0	A6
X 5 FORWARD	1	0	1	0	0	1	1	1	A7
SKIP FORWARD 10	1	0	1	1	0	0	0	1	B1
SKIP FORWARD 20	1	0	1	1	0	0	1	0	B2
SKIP FORWARD 30	1	0	1	1	0	0	1	1	B3
SKIP FORWARD 40	1	0	1	1	0	1	0	0	B4
SKIP FORWARD 50	1	0	1	1	0	1	0	1	B5
SKIP FORWARD 60	1	0	1	1	0	1	1	0	B6
SKIP FORWARD 70	1	0	1	1	0	1	1	1	B7
SKIP FORWARD 80	1	0	1	1	1	0	0	0	B8
SKIP FORWARD 90	1	0	1	1	1	0	0	1	B9
SKIP FORWARD 100	1	0	1	1	1	0	1	0	BA

FIGURE 5b: LD-V1000 COMPUTER INTERFACE  
COMMANDS - PART 2

#### IV. SOFTWARE INTERFACE CONSIDERATIONS

##### 1. General Comments

The user's primary concern when creating a software interface to the LD-V1000 Player should be to insure that the host port and the player data bus are never in the output state at the same time. Leaving the host port in the input state at all times except during command application will prevent this contention. During command application to the player, the software will be time critical from the beginning of the status strobe to the end of the command strobe. Interrupts and DMA operations (such as display generation in the host computer) should be avoided during this 80us. period.

##### 2. Program Interface Sequence of Events

The software interface program should be designed to cause the following steps to occur, in the order indicated. Figure 6 shows the approximate timing values for this sequence of events. Figure 7 shows the linear sequence of events.

Step a. Put the host port in the input state and wait for the falling edge of the status strobe.

Step b. After the falling edge of the status strobe is detected, read the data from the host port.

Step c. Wait for the status strobe rising edge.

Optional

Step d. Check bit eight (DIO8) to confirm that the player is ready to receive another command: e.g., zero is busy and one is ready.

NOTE: All commands can be sent to the player at any time; but commands like SEARCH and AUTOSTOP will be aborted if another motion command is given before they have completed execution. The AUDIO, DISPLAY, RECALL, STORE, DISPLAY ENABLE, DISPLAY DISABLE, CLEAR, and 0 through 9 commands can be given without affecting the current motion state.

Step e. At this point, the player data bus is in the input state. The interface program should now put the host port in the output state and write the command to it. It should then wait for the end of the command strobe.

Step f. Put the host port back into the input state to complete the cycle.

This sequence needs to be performed two times for each command sent to the player -- first with the data 'FF' (NO ENTRY) and then with actual command data applied for the next command strobe. The command data may be repeated as many times as desired. However, only the first non-'FF' command is significant for all commands other than SCAN. (While all this might possibly be accomplished through interrupts, a fairly fast interrupt response time would be essential.)



Symbol	Description	Approx. Value
Tsw	STATUS STROBE	26 $\mu$ s
Tcw	COMMAND STROBE	25 $\mu$ s
Tsc	STATUS STROBE to COMMAND STROBE	54 $\mu$ s or 84 $\mu$ s
Tsd	STATUS STROBE to STATUS DATA	30 ns
Tcyc	CYCLE TIME	16.6ms PLAY 21.0ms PARK
Tvs	Delay after vertical sync. until STATUS STROBE	500 to 650 $\mu$ s
Tsi	STABLE INPUT	less than 4 $\mu$ s

**FIGURE 6: APPROXIMATE TIME VALUES**

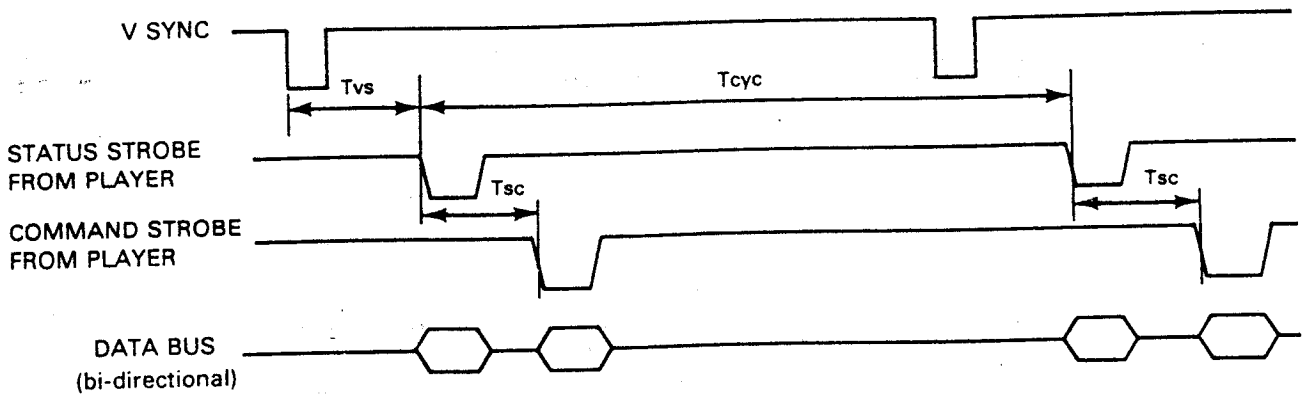
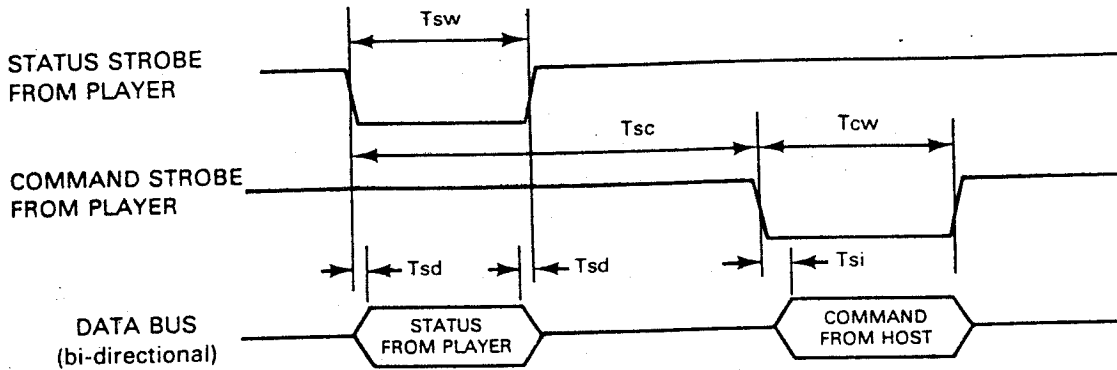

**FIGURE 7: LINEAR SEQUENCE OF EVENTS**

Figure 8 illustrates the sequence of events for one actual command -- the "1 SEARCH" command, issued while the player is in normal PLAY mode.

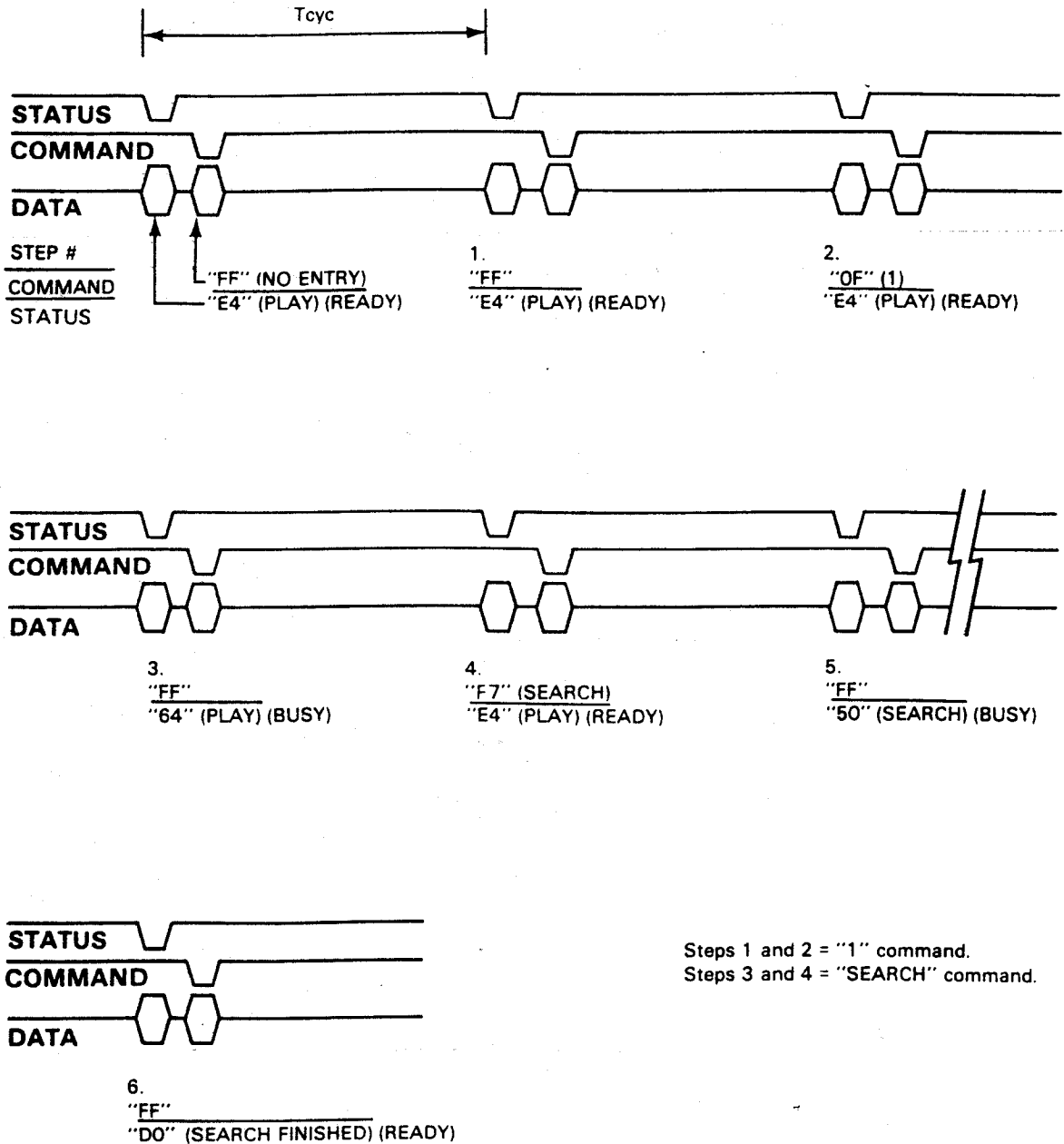
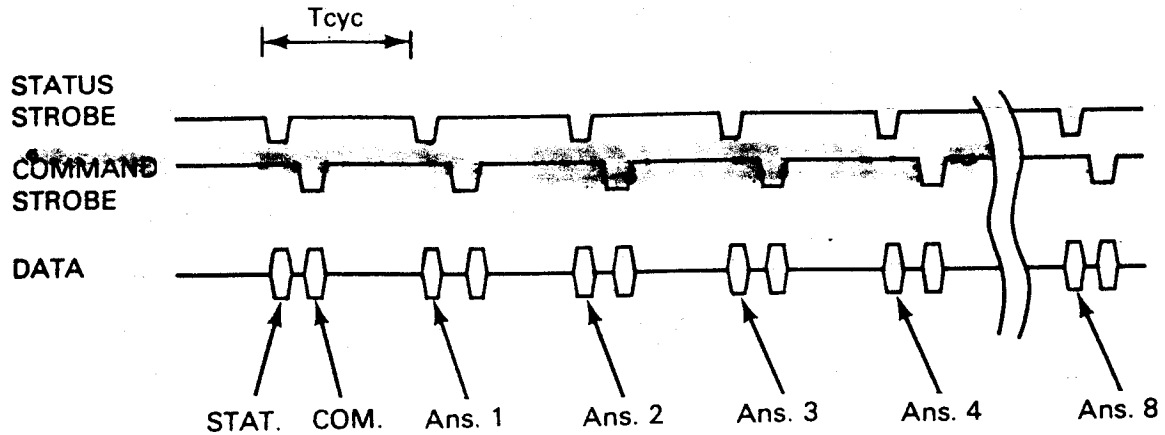

FIGURE 8: COMMAND TIMING EXAMPLE

### 3. Player-to-host Data Transmission Protocol

Figure 9 indicates the protocol and timing for player-to-host status reporting when the following commands are executed:

- GET FRAME NUMBER
- GET FIRST DISPLAY
- GET SECOND DISPLAY
- TRANSFER MEMORY



COMMAND				TRANSFER MEMORY
	GET FRAME #	GET 1st DISPLAY	GET 2nd DISPLAY	
Ans. 1	↑ MSB $10^4$	↑ Left most character	↑ Left most character	Mem. Loc. 1023
Ans. 2	$10^3$			
Ans. 3	$10^2$			
Ans. 4	$10^1$			
Ans. 5	↓ LSB $10^0$	Right most character	Right most character	
Ans. 6	--	'1C'	'1C'	Mem. Loc. 0
Ans. 7	--	'1C'	'1C'	
Ans. 8	--	'1C'	'1C'	
# of bytes returned	5	8	8	1024

**FIGURE 9: PLAYER-TO-HOST DATA PROTOCOL**

## V. APPENDIX

The following information is presented for your convenience:

- o Figure 10: Status Code Summary
- o Figure 11: LD-V1000 Command Byte Chart
- o LD-V1000 Player Specifications

Note: The STATUS commands returned will, in general, depend upon command execution timing, which in turn is frequently dependent upon waits for "Field One" (the field which contains the Frame Number Code).

PLAYER STATUS	TRANSMITTED STATUS VALUE									
	BINARY								HEX	DECIMAL
	8	7	6	5	4	3	2	1		
PARK	•	1	1	1	1	1	0	0	FC/7C	252/124
PLAY	•	1	1	0	0	1	0	0	E4/64	228/100
STOP	•	1	1	0	0	1	0	1	E5/65	229/101
SEARCH	0	1	0	1	0	0	0	0	50	80
SEARCH FINISH	1	1	0	1	0	0	0	0	D0	208
SEARCH ERROR	1	0	0	1	0	0	0	0	90	144
AUTOSTOP	0	1	0	1	0	1	0	0	54	84
SCAN	0	1	0	0	1	1	0	0	4C	76
FORWARD speeds	•	0	1	0	1	1	1	0	AE/2E	174/46
LOAD	0	1	0	0	1	0	0	0	48	72
LOAD END	1	1	0	0	1	0	0	0	C8	200
LOAD ERROR	1	1	0	0	0	1	0	0	C4	196
FOCUS UNLOCK	1	0	1	1	1	1	0	0	BC	188
LEAD-IN	0	1	0	1	1	0	0	0	58	88
LEAD-OUT	0	1	0	1	1	1	0	0	5C	92
REJECT	0	1	1	0	0	0	0	0	60	96

FIGURE 10: STATUS CODE SUMMARY

		COMMAND BYTES																					
		0	1	2	3	4	5	6	7	8	9	A	B	C	D	E	F						
LOW ORDER BITS	0												X0FWD						SCAN FWD	0			
	1												X1FWD	SKIP FWD 10						DISPLAY	1		
	2												X1FWD	SKIP FWD 20	GET FRAME							2	
	3												X1FWD	SKIP FWD 30	GET 2nd DISPLAY						AUTO STOP	3	
	4												X2FWD	SKIP FWD 40	GET 1st DISPLY						AUDIO 1	4	
	5												X3FWD	SKIP FWD 50						STORE	5		
	6												X4FWD	SKIP FWD 60						STEP FWD	6		
	7												X5FWD	SKIP FWD 70						SEARCH	7		
	8														SKIP FWD 80	TRANSFER MEMORY						SCAN REV	8
	9														SKIP FWD 90						REJECT	9	
	A														SKIP FWD 100							A	
	B																		LOAD	STOP	B		
	C																		DISPLAY DISABLE	AUDIO 2	C		
	D																		DISPLAY ENABLE	PLAY	D		
	E																			STEP REV	E		
	F	1	7	4	0	3	9	6	RECALL	2	8	5	CLEAR							F			
		0	1	2	3	4	5	6	7	8	9	A	B	C	D	E	F						
		HIGH ORDER FOUR BITS OF BYTE																					

FIGURE 11: LD-1000 COMMAND BYTE CHART

# LD-V1000 LaserDisc<sup>tm</sup> Player Specifications

## General Description

Laser type/wavelength	HeNe, 6328 Angstrom
Pickup direction	Reads from bottom
Disc loading	Top
Operation	Computer control
Remote control	None
Computer interface	8-bit parallel bi-directional
Power	120V $\pm$ 10%, 60Hz
Power consumption	Approx. 60W (Play)

## Environmental Requirements

Operating temperature	5 to 35°C (41 to 95°F)
Humidity, operating	0 to 90%, non-condensing
Storage temperature	-20 to 60°C (-4 to 140°F)
Storage humidity	0 to 90%, noncondensing

## Dimensions

HxWxD	5.6 x 20.7 x 15.6 inches 14.3 x 52.5 x 39.5 cm
Weight, net	28.7 lbs. (13 Kg)
Weight, shipping	34.2 lbs. (15.5 Kg)

Moving Component                      Optical sled

Disc Compatability                      CAV only, standard or aluminum backed

User RAM                                      1K Bytes (for data storage)

## Performance

Initial start time	13 sec. standard disc; 18 sec. aluminum
Stop cycle time	8 sec. standard disc; 10 sec. aluminum
Maximum search time	Approx. 3 sec.

## Motion Controls

Play	Yes
Fast play	X2, X3, X4, and X5 forward
Slow play	X1/2 and X1/4 forward
Step	Forward and reverse
Freeze frame	Yes
Scan	Forward and reverse
Search	Yes (frame accurate)
Autostop	Yes (frame accurate)
Action at lead-out	Send lead-out status
Multi-track skip	10, 20, ... 100 tracks forward in less than 5 ms (At least 170 ms settling time is required between skips.)

## Displays and Output Controls

Display contents	Frame number, active argument, register number, and register contents (Displays can be disabled without affecting contents.)
Audio selection	Two channels, audio output possible during FAST and SLOW play modes

## Player Memory

RAM size	2K bytes (1K user dump RAM)
Digital data dump	Disc to RAM, MCA format

## Computer Interface

Interface	8-bit parallel, bi-directional
Interface speed (nominal)	33ms per command byte input, 17ms per command byte output
Input	Commands
Output	Status, RAM contents, frame number, or contents of display

## Video Signal Characteristics

Signal Format, line	NTSC
Video Signal Level, line	1V P/P nominal into 75 Ohm termination
Frequency response	4.1 MHz, -6db
Signal-to-noise ratio	Better than 40db
Horizontal resolution	Approx. 350 lines
Time base error	+ 22ns max. (outside vertical blanking interval)
Video sync output during search	Yes

## Audio Signal Characteristics

Channels	2
Output levels, line	650 mv RMS nominal (1KHz at 100% modulation, 50K Ohm termination)
Frequency response	40 to 20KHz + 3db (reference 1KHz 10% modulation)
Signal-to-noise ratio	More than 50db
Total harmonic distortion	Less than 0.5% (1KHz at 75% modulation)

## Controls on Front Panel

Power	Button and indicator
Reject/Lid open	Button

## Connectors on Back Panel

Video Line Out	BNC connector
Audio Lines Out	Two RCA (phono) jacks
Computer Interface	24 pin Amphenol Series 57
Power	1.7 meter AC cord; polarized, 2-pin plug